







COMMERCIAL
BULBS.COM

REFERENCE GUIDE

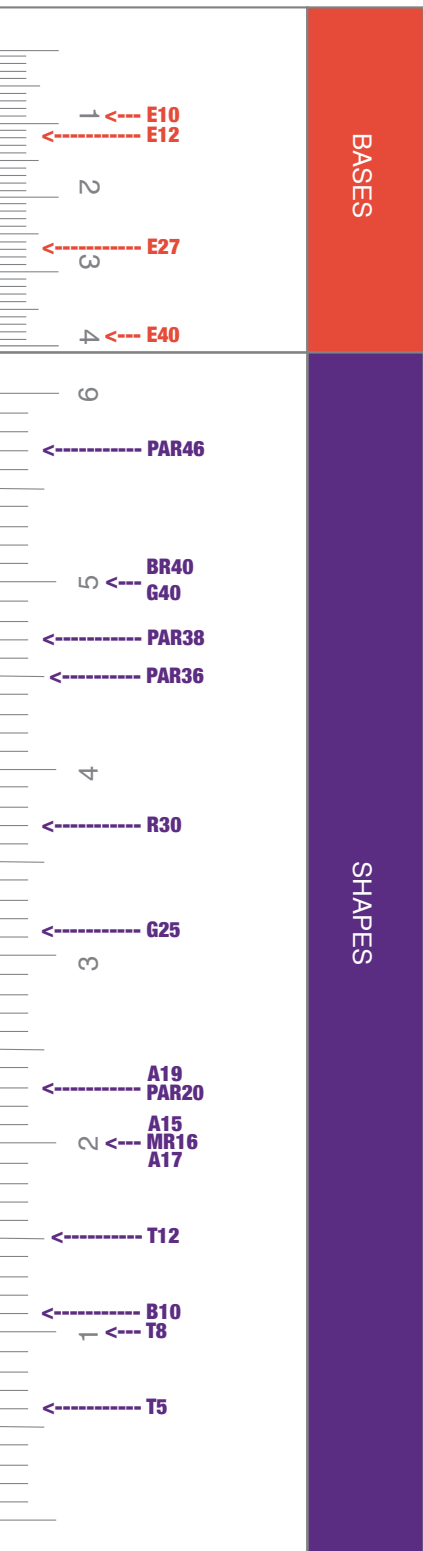
IN-DEPTH LOOK ON SHAPES, BASES, AND MORE.

TABLE OF CONTENTS



 www.commercialbulbs.com
 sales@commercialbulbs.com
 847-675-3538
 708-843-5888

04

GENERAL INFORMATION

- 05 INCANDESCENT BULBS
- 06 HALOGEN BULBS
- 07 FLUORESCENT BULBS
- 08 LED BULBS
- 09 HID BULBS
- 10 CFL LAMPS
- 11 BALLASTS
- 12 LUMENS & LIGHT OUTPUT
- 13 COLOR TEMPERATURE

15

LAMP SHAPES

15 A SERIES	18 HID
15 B SERIES	18 LFL
15 BR/ER SERIES	19 MR SERIES
16 C SERIES	19 PAR SERIES
16 CA SERIES	19 PS SERIES
16 CFL	19 R SERIES
16 CFL PLUG-IN	19 RP + S SERIES
17 ET PRISM SERIES	20 SPECIALTY
17 G SERIES	20 T SERIES

21

LAMP BASES

- 21 A: GENERAL BASES
- 21 B: COMPACT FLUORESCENT BASES
- 22 C: FLUORESCENT BASES
- 22 D: BI-PIN BASES
- 22 AR/ARL
- 22 E SERIES
- 23 PAR
- 23 SPECIALTY

Our Philosophy:

At **Commercial Bulbs**, we don't just sell any product. We carefully research all new products and manufacturers, and meticulously track any and all issues. Because of that, we personally stand behind all warranties. We don't make you deal with the manufacturer, if a replacement is needed we will send it to you at no cost.

It is our fundamental belief that in order to succeed, we need to provide an exceptional product at an exceptional price, coupled with an unparalleled customer service experience. A representative is always available to take your call or if we are helping another customer, leave a message and we'll call you back. We strive to give each customer the individual attention that they deserve. If you need our assistance after normal business hours, we are here to help. Our voicemails and emails are monitored 7 days a week. If you find any product we sell in comparable quantity, for less, we'll beat their price - not just for you, but for all of our customers.

BUY. BULBS. BETTER.



Pros

- Low cost

Cons

- High power
- Short lamp life

INCANDESCENT

Not much has changed since the Incandescent Bulb was invented by Thomas Edison in the late 1800's. When a metal filament is heated to high temperatures, it begins to glow and emit light, called Incandescence. The Incandescent Bulb is very basic in its design and typically consists of 3 parts:

1. Base - How the lamp is installed and makes connection.
2. Glass - Which insulates the filament, usually vacuum sealed or gas filled.
3. Filament - Thin metal strip, usually made of tungsten.

In order for the lamp to emit its intended lumens, it must be used with a specific voltage range. Incandescent bulbs are made in a variety of versions with 120v and 130v being the most common in the U.S.

Pros

- Very bright
- Longer life than Incandescent

Cons

- Extremely hot
- High energy consumption



Pros

- Consumes 75% less than Incandescent

Cons

- Quality of light



HALOGEN

Halogen Bulbs work similarly to Incandescent technology, but improve upon the process. Halogen Lamps deliver a crisp, white light, and render colors better than Incandescent technology. Halogen bulbs are named for the Halogen Cycle that occurs in the bulb. Gas is inserted at a high-pressure and sealed off. The Halogen bulb operates at a higher temperature, which causes the tungsten in the filament to evaporate.

Both Incandescent and Halogen use tungsten filaments, but where the filament in an Incandescent Bulb will weaken and break - the gasses in the Halogen Bulb redeposit the tungsten back into the filament. This allows for a longer lamp life.

FLUORESCENT

Fluorescent lamps emit light through a process called Fluorescence. The ballast provides an electric current through the mercury vapor in the tube, this causes a short wave ultraviolet light, which causes a phosphor coating on the inside of the lamp to glow.

The typical luminous efficacy of a fluorescent system is 50-100 lumens per watt, several times the efficacy of incandescent bulbs with comparable light output.

Pros

- High lumens per watts
- Low heat
- Long life

Cons

- Higher cost
- Not available for all applications



Pros

- High efficacy

Cons

- Low CRI



LED

Light Emitting Diode bulbs produce light from a semiconductor. The semiconductor, which has both positive and negative energy, has electricity stimulate free-floating electrons on the negative layer. These electrons cross to the positive side, which has holes for the electrons to enter and exit. This movement produces light. There are 4 basic components to an LED bulb:

1. Chip - The semiconductor that produces the light, mounted on a heat conducting material.
2. Heat Sink - The surround made of a material that draws the heat away from the semi-conductor.
3. Driver - The driver regulates the proper voltage to the chip.
4. Optics - The cover on the chip which directs the light output and gives LED their focused beams.

HID

High Intensity Discharge bulbs work similarly to Fluorescent bulbs, but do not need a phosphor coating to convert the light. In a HID bulb, the gas is forced in at a very high pressure. To withstand the pressure, all the elements are housed in what is known as, the "arc tube", which is made from quartz or transparent ceramic. HID Lamps have a "burn-in" period of about 100 hours before the color they emit stabilizes. As the bulb ages, chemical changes in the lamp can also cause the color to shift. There are 3 different lamp types in the HID category:

1. Mercury Vapor - Produces a blue/white light, with poor color rendering. Best for outdoor applications. Mercury Vapor Lamps typically last 1,000 to 24,000 hours.
2. Metal Halide - Comparable to Mercury Vapor with the addition of metal halide gas. This improves their efficiency and color.
3. High Pressure Sodium - Gives off an orange/white light. Brighter and longer lasting then both metal halide and Mercury Vapor, but poor color rendering.

Pros

- Uses 90% less energy than Incandescents
- Lasts 10x's longer

Cons

- Higher cost
- Carries traces of mercury



CFL

Compact Fluorescent Lamps, or CFLs as they are commonly known, have quickly become the go to replacement for incandescent bulbs in nearly every application. A spiral shaped tube commonly replaces the incandescent look and instead of a filament, contains an Argon and Mercury vapor mixture. CFLs like their long tube shaped cousins need a ballast which is usually found in the base of the bulb.

This ballast produces an electrical current, which runs through the gas mixture causing it to emit ultraviolet light. This light interacts with a phosphorous coating painted on the inside of the tube. As the UV passes through this coating it is absorbed and converted to visible light, seen outside the glass.



BALLAST POWER FACTORS:

- L** - Ballast gives you the “least necessary” light but you save on energy bill.
- N** - Normal and energy and light.
- H** - High Power. It uses lots of energy but in return gives you lots of light.
- HO** - Stands for High Output. It gives you THE MOST Light.

BALLAST TYPES

- A ballast with yellow wires is a **PROGRAMMED START**.
- A ballast without yellow wires is an **INSTANT START**.

RAPID START:

Rapid start ballasts ignite lamps by providing cathode voltage (heat) and voltage across the lamp simultaneously. As the cathodes heat, the voltage required to ignite the lamp is reduced. At some point after both voltages are applied, the cathodes reach a temperature sufficient for the applied voltage to ignite the lamps.

TIP: PROGRAMMED START:

In programmed start ballasts, cathode voltage (heat) is applied for a programmed period of time. Once that time is complete, then the cathode voltage is turned off, and lamp voltage is applied, igniting the lamp. This programmed method allows the lamps to be ignited with a minimal loss of emissive material.

TIP: INSTANT START:

Instant start ballasts ignite lamps by applying a significant voltage across the lamp during starting. However, no cathode heating is applied before or after the lamps are ignited. Since the cathodes are not heated with instant start ballasts, emissive material is also released during this type of scenario.

LUMENS & LIGHT OUTPUT

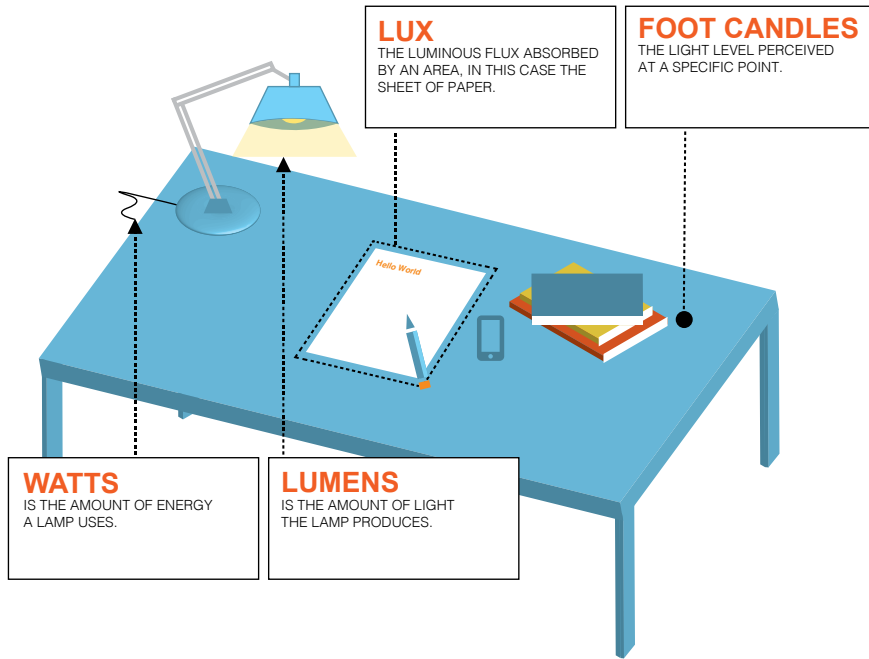

TYPE OF ACTIVITY	SUGGESTED LEVELS (FOOTCANDLE)
Public spaces with dark surroundings	3
Simple orientation for short temporary visits	7
Working spaces where visual tasks are only occasionally performed	15
Performance of visual tasks of high contrast or large size	35
Performance of visual tasks of medium contrast or small size	75
Performance of visual tasks of low contrast or very small size	150
Performance of visual tasks of low contrast and very small size over a long prolonged period	300
Performance of very prolonged and exacting visual tasks	750
Performance of very special visual tasks of extremely low contrast and small size	1500

COLOR TEMPERATURE

The Kelvin is the numerical reference of how warm (yellow), or cool (blue) a light source is, or its 'color temperature.' Older lighting technologies such as Incandescent or Halogen were limited to a specific color temperature, generally 2700 to 3000 in those cases.

Newer technology however, such as LED, can be manufactured in an entire range of color temperatures. The chart below shows both natural and man-made light sources relative to one another.

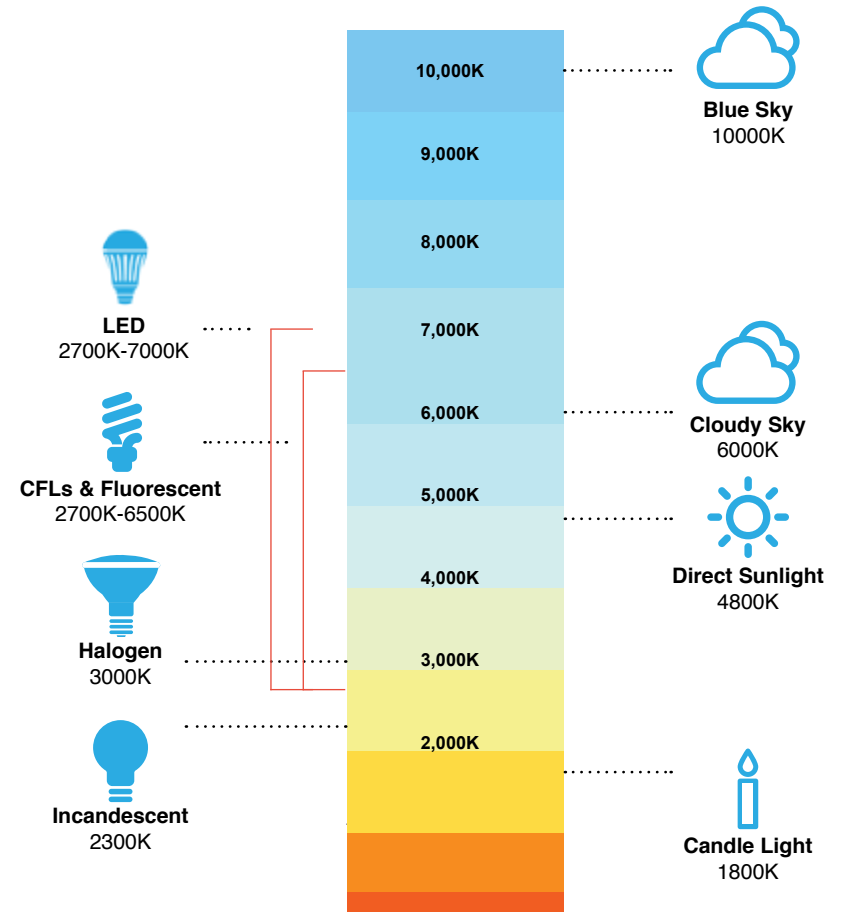

LAMP SHAPE

A series

ARBITRARY SPHERICAL

A Shape lamps are the most common. The number is the diameter of the widest part of the lamp in eighths. In the case of an A19, it would be 19/8's, or 2-3/8" in diameter.

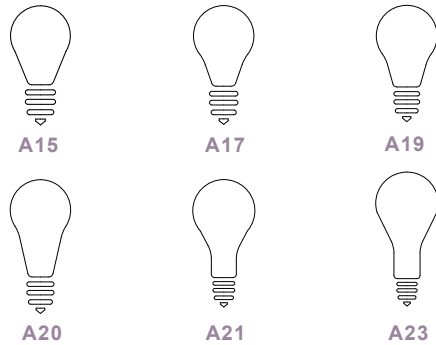

B series

BULGED LAMPS

B is short for Bulged. The number is the diameter of the widest part of the lamp in eighths. For instance, a B10 would be 10/8's, or 1-1/4" in diameter.

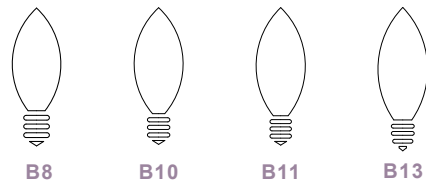

BR/ER series

BLOWN REFLECTOR

BR is short for Blown Reflector. The number is the diameter of the end of the lamp in eighths. For instance, a BR30 would be 30/8's, or 3-3/4" in diameter.

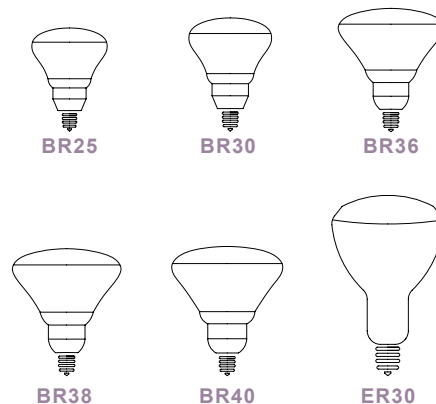

C series

CANDELABRA LAMPS

C is short for Candelabra. The number is the diameter of the widest part of the lamp in eighths. For instance, a C7 would be 7/8's in diameter.

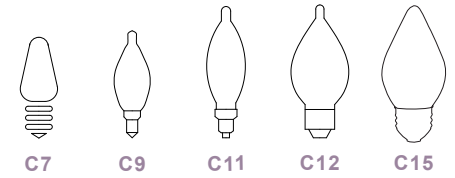

CA series

CANDLE ANGULAR

CA is short for Candle Angular. The number is the diameter of the widest part of the lamp in eighths. For instance, a CA5 is 5/8's in diameter.

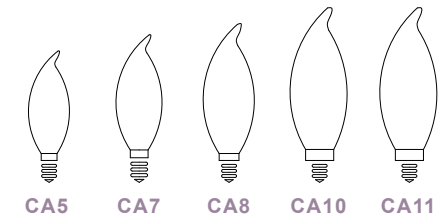

CFL SCREW-IN

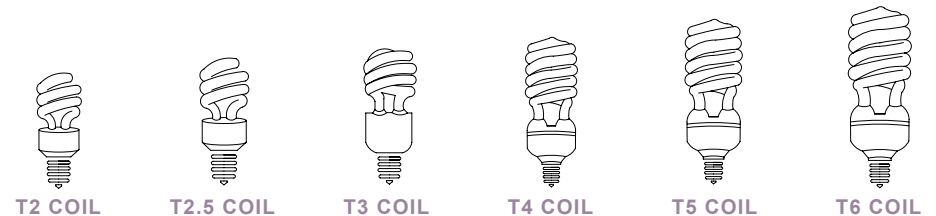

LAMP SHAPE

CFL PLUG-IN

ET/Prism series

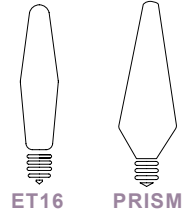
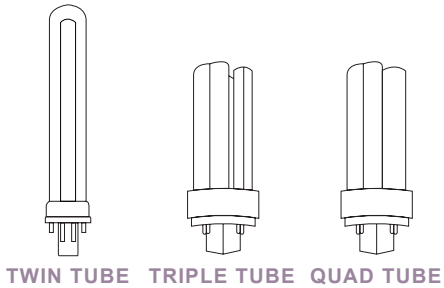

G series

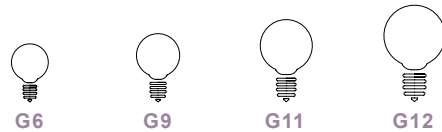

GLOBE SHAPE

G is short for Globe. The number is the diameter of the widest part of the lamp in eighths. For instance, a G40 would be 40/8's, or 5" in diameter.

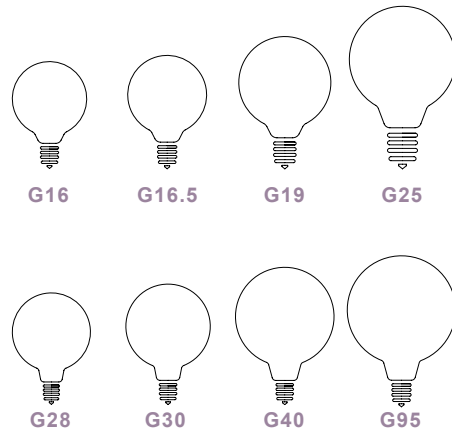

HID

HIGH INTENSITY DISCHARGE

B is short for Bulged. BT is short for Bulged Tubular. E is short for Ellipsoidal. ED is short for Ellipsoidal Dimple. The number is the diameter for the widest part of the lamp in eighths. For instance, a B17 would be 17/8's, or 2-1/8" in diameter.

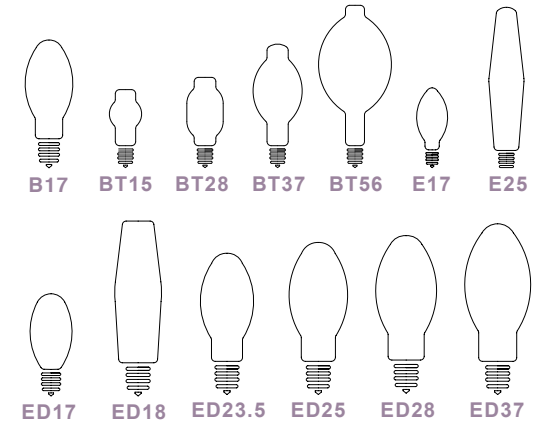

LFL

LINEAR FLUORESCENT

LFL is short for Linear Fluorescent Lamp. The number is the diameter of the lamp in eighths. For instance, a T8 would be 8/8's in diameter, or 1" in diameter.

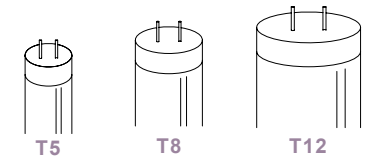

MR series

MULTIFACETED REFLECTOR

MR is short for Multifaceted Reflector. These lamps are generally used in spot lamps and track lights. The numerical part of the shape is the diameter of the end of the lamps in eighths. For instance, a MR16 would be 16/8's, or 2" in diameter.



LAMP SHAPE

PAR series

PAR LAMPS

PAR is short for Prismatic Aluminized Reflector. The number is the diameter of the widest part of the lamp in eighths. For instance, a PAR16 would be 16/8's, or 2" in diameter.

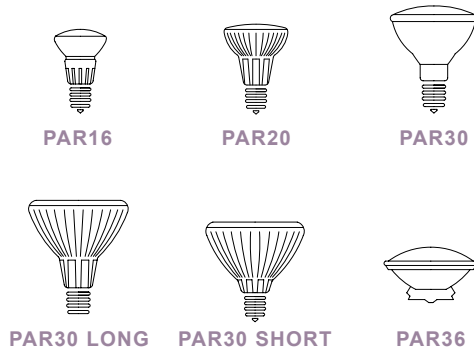

RP + S series

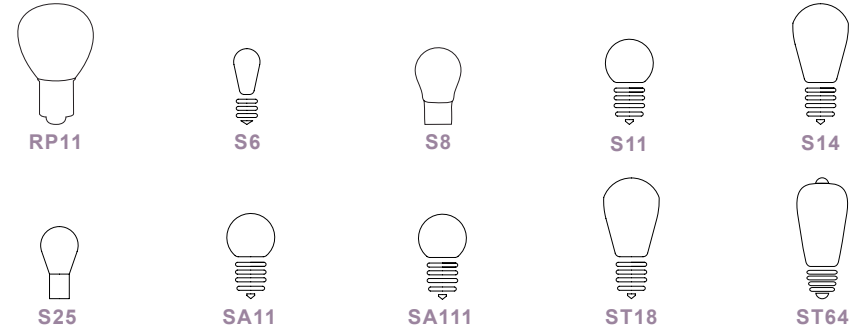

PS series

PEAR SHAPED LAMPS

PS is short for Pear Shaped. The number is the diameter of the widest part of the lamp in eighths. For instance, a PS25 would be 25/8's, or 3-1/8" in diameter.

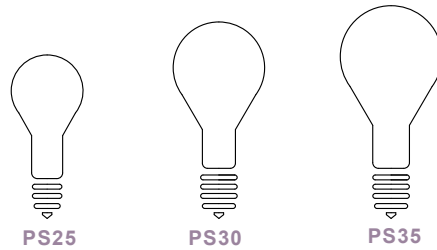

SPECIALTY

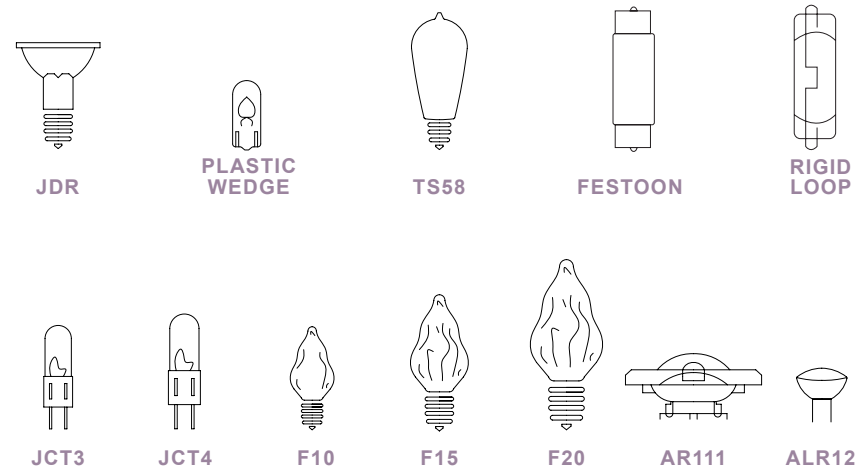

R series

REFLECTOR

R is short for Reflector. The numerical part of the shape is the diameter of the end of the lamp in eighths. For instance, a R30 would be 30/8's, or 3-3/4" in diameter.

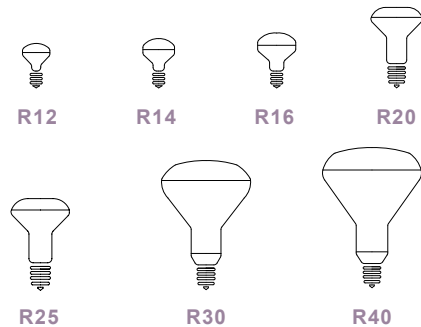

T series

TUBULAR LIGHT BULBS

T is short for Tubular. The number is the diameter of the lamp in eighths. For instance, a T10 would be 10/8's, or 1-1/4" in diameter.

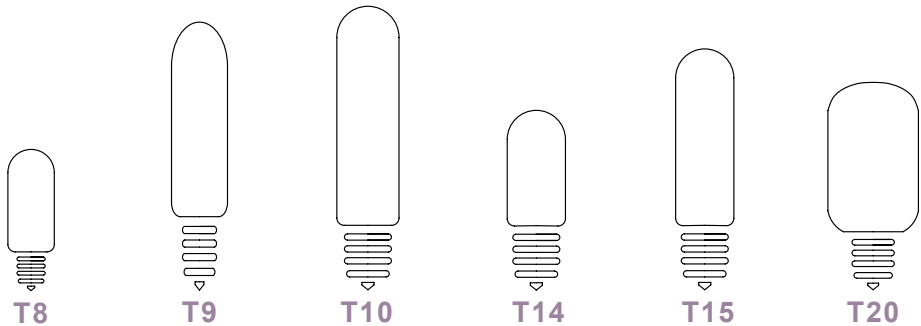
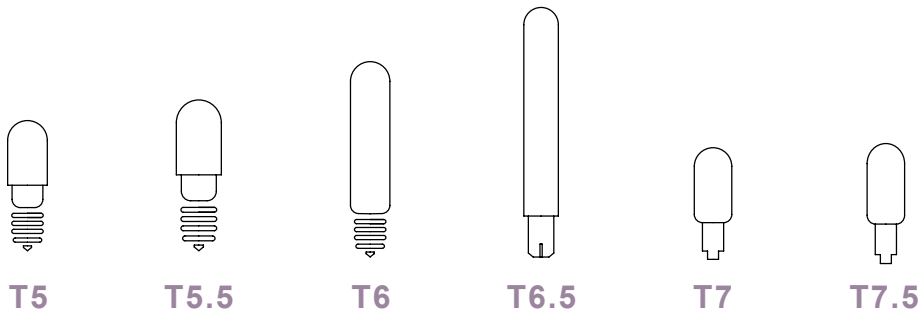
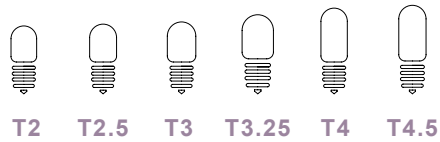

SCREW IN

Screw in E type bases are the most common. The numerical part is the diameter of the base in millimeters. For instance, an E27 is 27 mm in diameter.

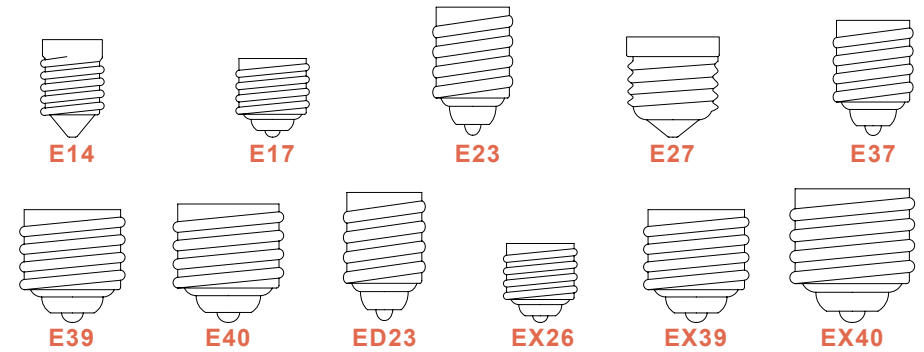

PLUG-IN FLUORESCENT BASES

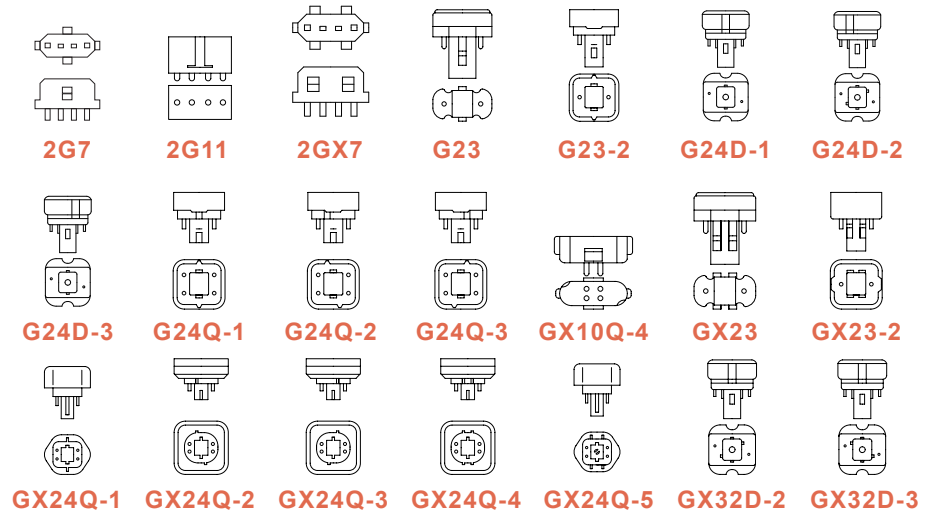

LAMP BASES

FLUORESCENT BASES

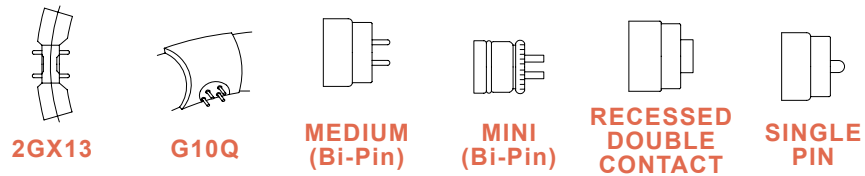

BI-PIN BASES

Bi-Pin bases are push in type pin bases. The numerical part of the base is the distance between the pins in millimeters. For instance, a G12 base would be 12mm from pin to pin.

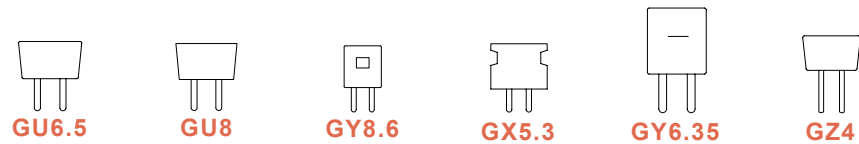
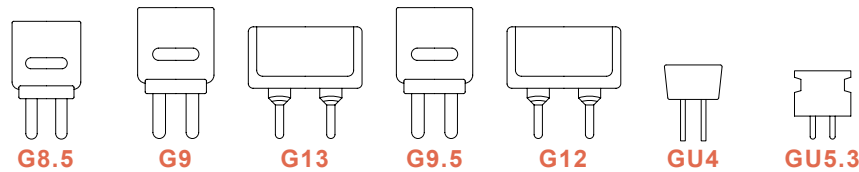
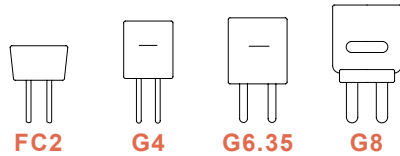

GU series

GU bases have pins with locking ends on them, and twist into the socket. The numerical part of the base is the distance between the pins in millimeters. For instance, a GU10 is 10mm from pin to pin.



SPECIALTY

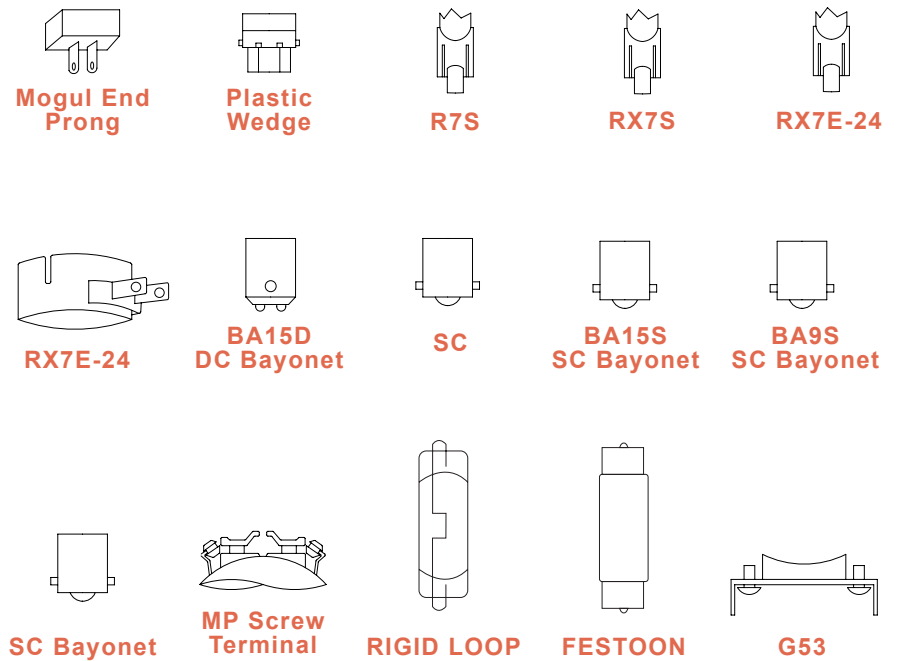



We are proud to offer high quality products to fill all your lighting needs.



At **CommercialBulbs.com**, we'll beat any competitor's price by 5%.



With our superb service and support, check us out today. What are you waiting for?

6990 North Central Park, Lincolnwood, Illinois 60712
847-675-3538 www.commercialbulbs.com